

Cast-Away™ Elbow

Warnings and Instructions: Review carefully, proper application is required

⚠ Warning: This device will not prevent or eliminate risk of injury. Do Not Overtighten. If swelling, pain, skin irritation, or an unusual reaction occurs, discontinue use immediately and consult your medical professional.

Care: Hand wash using mild soap. Rinse thoroughly. Air dry only. Do not tumble dry.

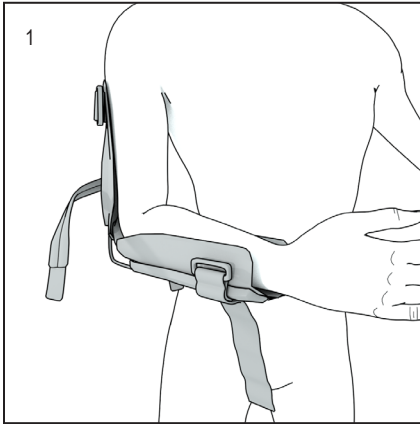

1. Place elbow in brace.

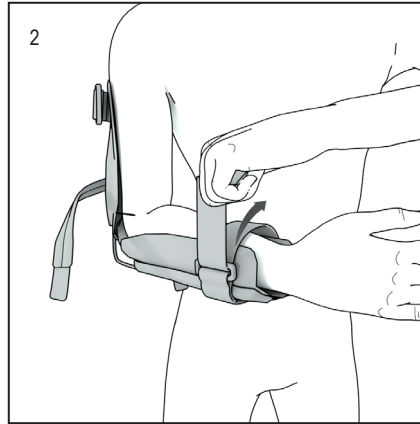

2. Put lower arm strap through buckle, pull and fasten.

Note: Straps can be detached and moved.

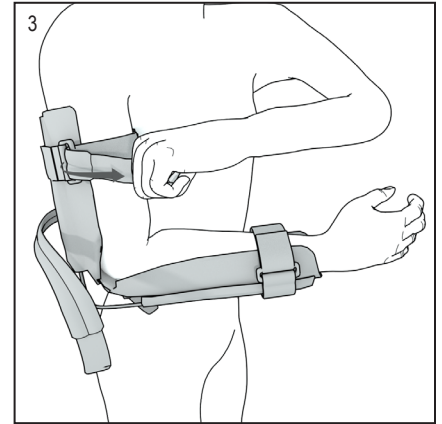

3. Put upper arm strap through buckle, pull and fasten.

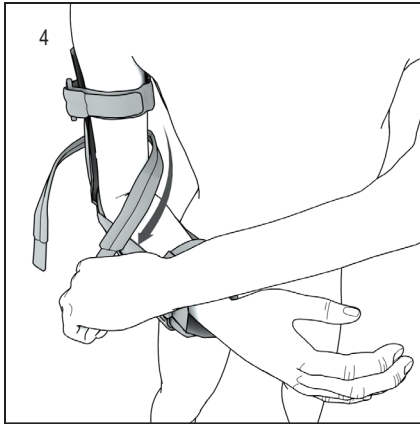

4. Bring inside strap across arm and attach at outside of brace.

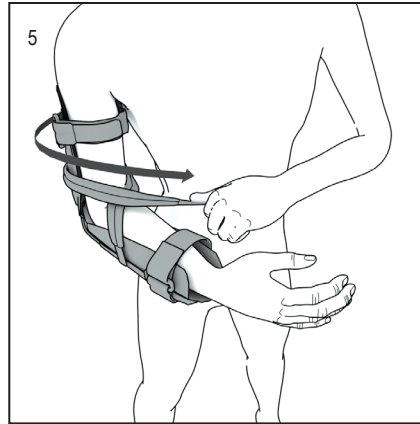

5. Bring outside strap across arm and attach at inside of brace.

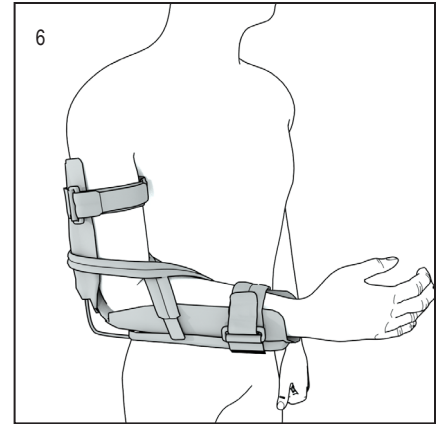

6. Re-adjust straps for fit and comfort.

Optional Improvements:

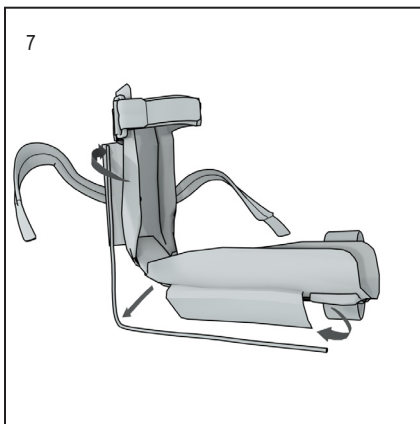

7. Remove brace to bend supports for desired position.

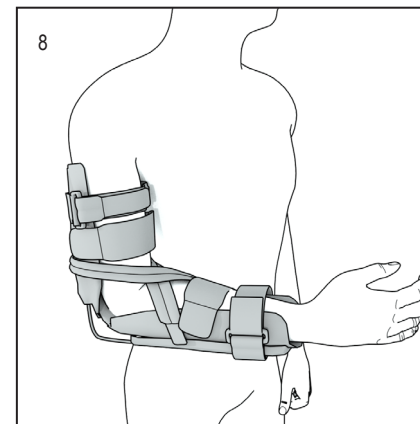

8. Attach optional straps as necessary.

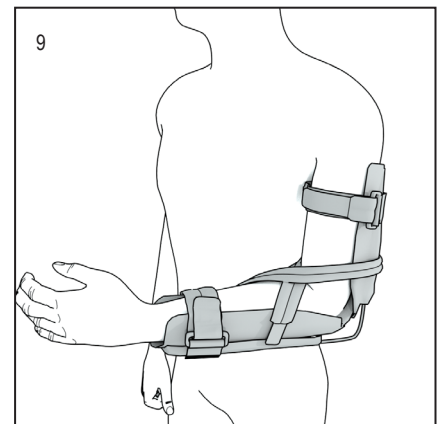

9. For left arm application: Remove straps with buckles and re-apply them with buckles on outside of arm.

Application Video



HELY & WEBER

© 2017 Weber Orthopedics Inc.
DBA Hely & Weber all rights reserved

